

TITLE : NV133FHM-N56 V8.0**Product Specification****Rev. P0****BOE Optoelectronics Technology Co., Ltd**

REVISION HISTORY Preliminary Specification Final Specification

Revision No.	Page	Description of Changes	Date	Prepared
P0	32	Preliminary Release	2017.12.25	Fu Siqing

REVIEWED

Designer	Manager
Mei Wenlin(Array)	Wang Rui
Tan Su(Cell)	Hu Jingyong
Liu Chao(CF)	Li Min
Zhang Ying(EE)	Lu Xu
Tan Sen(MO)	Gao Liang
Mou Bingkai(QE)	Huang Yuan
Chen Gang(PI)	Wang Zhihui

APPROVED

Fu Siqing(PM)

Contents

No.	Items	Page
1.0	General Description	4
2.0	Absolute Maximum Ratings	6
3.0	Electrical Specifications	7
4.0	Optical Specifications	10
5.0	Interface Connection	15
6.0	Signal Timing Specification	19
7.0	Input Signals, Display Colors & Gray Scale of Colors	21
8.0	Power Sequence	22
9.0	Connector Description	23
10.0	Mechanical Characteristics	24
11.0	Reliability Test	25
12.0	Handling & Cautions	25
13.0	Label	26
14.0	Packing Information	28
15.0	Mechanical Outline Dimension	29
16.0	EDID Table	31

1.0 GENERAL DESCRIPTION

1.1 Introduction

NV133FHM-N56 V8.0 is a color active matrix TFT LCD module using amorphous silicon TFT's (Thin Film Transistors) as an active switching devices. This module has a 13.3 inch diagonally measured active area with Full-HD resolutions (1920 horizontal by 1080 vertical pixel array). Each pixel is divided into RED, GREEN, BLUE dots which are arranged in vertical stripe and this module can display 262k(6bit) colors and color gamut 72%. The TFT-LCD panel used for this module is a low reflection and higher color type. Therefore, this module is suitable for Notebook PC. The LED driver for back-light driving is built in this model.

All input signals are eDP1.3 interface compatible.

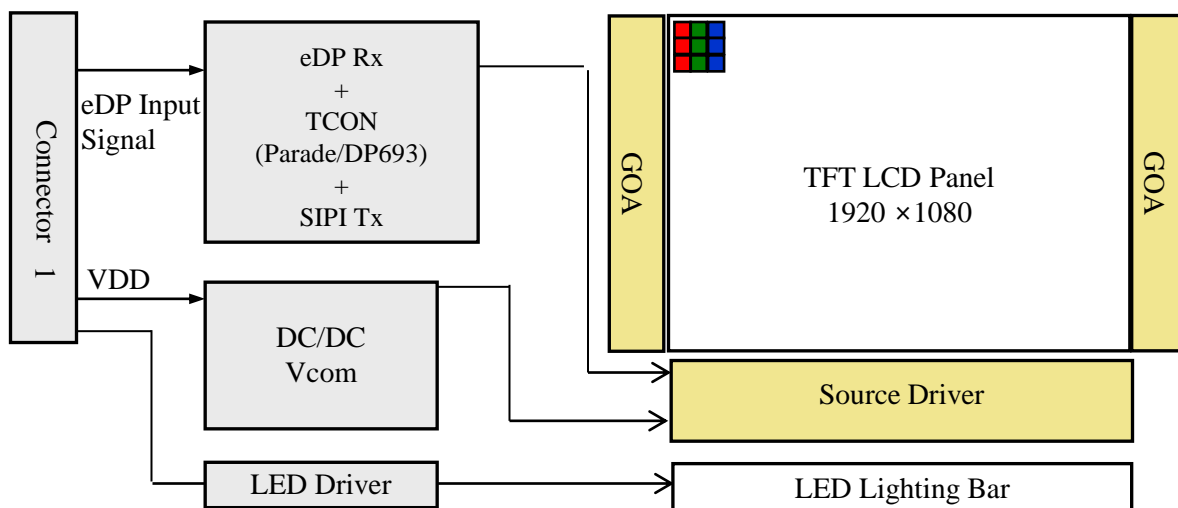

Figure 1. Drive Architecture

1.2 Features

- 2 lane eDP interface with 2.7Gbps link rates
- Thin and light weight
- 262k(6bit) color depth, color gamut 72%
- Single LED lighting bar (Bottom side/Horizontal Direction)
- Data enable signal mode
- Side mounting frame
- Green product (RoHS & Halogen free product)
- On board LED driving circuit
- Low driving voltage and low power consumption
- On board EDID chip

1.3 Application

- Notebook PC (Wide type)

1.4 General Specification

The followings are general specifications at the model NV133FHM-N56 V8.0 (listed in Table 1)

<Table 1. General Specifications>

Parameter	Specification	Unit	Remarks
Active area	293.76(H) × 165.24(V)	mm	
Number of pixels	1920 (H) × 1080 (V)	pixels	
Pixel pitch	153(H) × 153(V)	um	
Pixel arrangement	RGB Vertical stripe		
Display colors	262k(6bit)		
Color gamut	72%		
Display mode	Normally Black		
Dimensional outline	299.96 (H)*186.92(V) w/PCB)*2.0Max	mm	2.1 Max @PCB Side
Weight	170(max)	g	
Surface treatment	HC		
Surface hardness	3H		
Back-light	Bottom edge side, 1-LED lighting bar type		Note 1
Power consumption	P _D : 0.8	W	@Mosaic
	P _{BL} : 2.8	W	
	P _{Total} : 3.6	W	@Mosaic

Notes : 1. LED Lighting Bar (40*LED Array)

2.0 ABSOLUTE MAXIMUM RATINGS

The followings are maximum values which, if exceed, may cause faulty operation or damage to the unit. The operational and non-operational maximum voltage and current values are listed in Table 2.

< Table 2. Absolute Maximum Ratings >

Ta=25+/-2°C

Parameter	Symbol	Min.	Max.	Unit	Remarks
Power Supply Voltage	V _{DD}	-0.3	4.0	V	Note 1
Logic Supply Voltage	V _{IN}	V _{SS} -0.3	V _{DD} +0.3	V	
Operating Temperature	T _{OP}	0	+50	°C	Note 2
Storage Temperature	T _{ST}	-20	+60	°C	

Notes :

1. Permanent damage to the device may occur if maximum values are exceeded functional operation should be restricted to the condition described under normal operating conditions.
2. Temperature and relative humidity range are shown in the figure below.
95 % RH Max. (40 °C ≥ Ta) Maximum wet - bulb temperature at 39 °C or less. (Ta > 40 °C) No condensation.

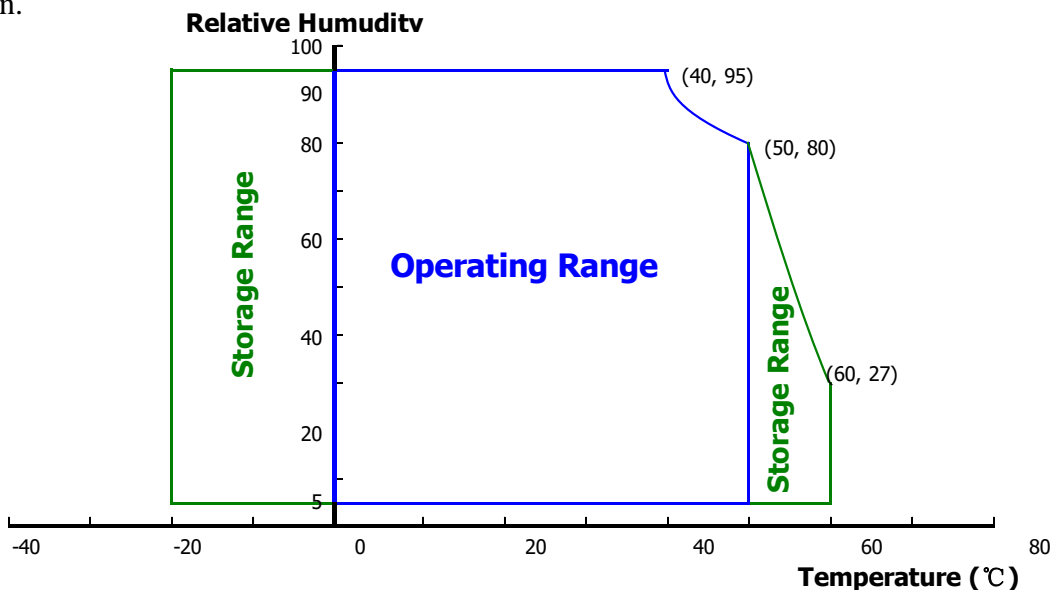

Figure 2. Temperature and Relative Humidity Range

3.0 ELECTRICAL SPECIFICATIONS

3.1 Electrical Specifications

< Table 3. Electrical Specifications >

Ta=25+/-2°C

Parameter		Min.	Typ.	Max.	Unit	Remarks
Power Supply Voltage	V _{DD}	3.0	3.3	3.6	V	Note 1
Permissible Input Ripple Voltage	V _{RF}	-	-	100	mV	@ V _{DD} = 3.3V
Power Supply Current	I _{DD}	-	242	485	mA	Note 1
Power Supply Inrush Current	I _{rush}	-	-	1.5	A	Note3
Power Consumption	P _D	-	0.8	1.6	W	Note 1
	P _{BL}	-	-	2.8	W	Note 2
	P _{total}	-	3.6	4.4	W	Note 1

Notes :

1. The supply voltage is measured and specified at the interface connector of LCM.

The current draw and power consumption specified is for 3.3V at 25 °C.

a) Typ : Mosaic pattern 8*8

b) Max : R/G/B patterns

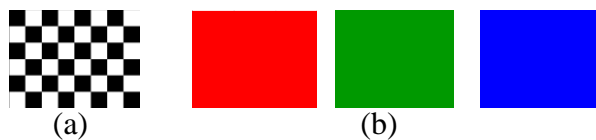

Figure 3. Power Measure Patterns

2. Calculated value for reference (V_{LED} × I_{LED})

3. Measure condition (Figure 4)

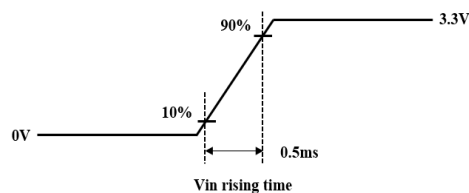

Figure 4. Inrush Measure Condition

3.2 Backlight Unit

< Table 4. LED Driving Guideline Specifications >

Ta=25+/-2°C

Parameter		Min.	Typ.	Max.	Unit	Remarks
LED Forward Voltage	V_F	-	-	3.0	V	
LED Forward Current	I_F	-	21.0	-	mA	
LED Power Consumption	P_{LED}	-	-	2.8	W	Note 1
LED Life-Time	N/A	15,000	-	-	Hour	$I_F = 20mA$
Power Supply Voltage for LED Driver	V_{LED}	5	12	21	V	
Power Supply Voltage for LED Driver Inrush	Iled inrush	-	-	1.5	A	Note 4
EN Control Level	Backlight On	2.5	-	5.0	V	
	Backlight Off	0	-	0.6	V	
PWM Control Level	High Level	2.5	-	5.0	V	
	Low Level	0	-	0.6	V	
PWM Control Frequency	F_{PWM}	200	-	10,000	Hz	
Duty Ratio		1	-	100	%	Note 3

Notes :

1. Power supply voltage 12V for LED driver.

Calculator value for reference $I_F \times V_F \times 40 / \text{driver efficiency} = P_{LED}$

2. The LED life-time define as the estimated time to 50% degradation of initial luminous.

3. 1% duty cycle is achievable with a dimming frequency less than 1KHz.

4. Measure condition (Figure 5)

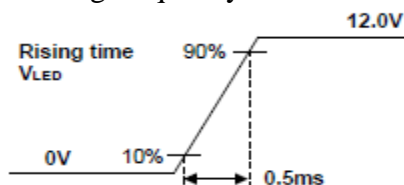

Figure 5. Inrush Measure Condition

3.3 LED Structure

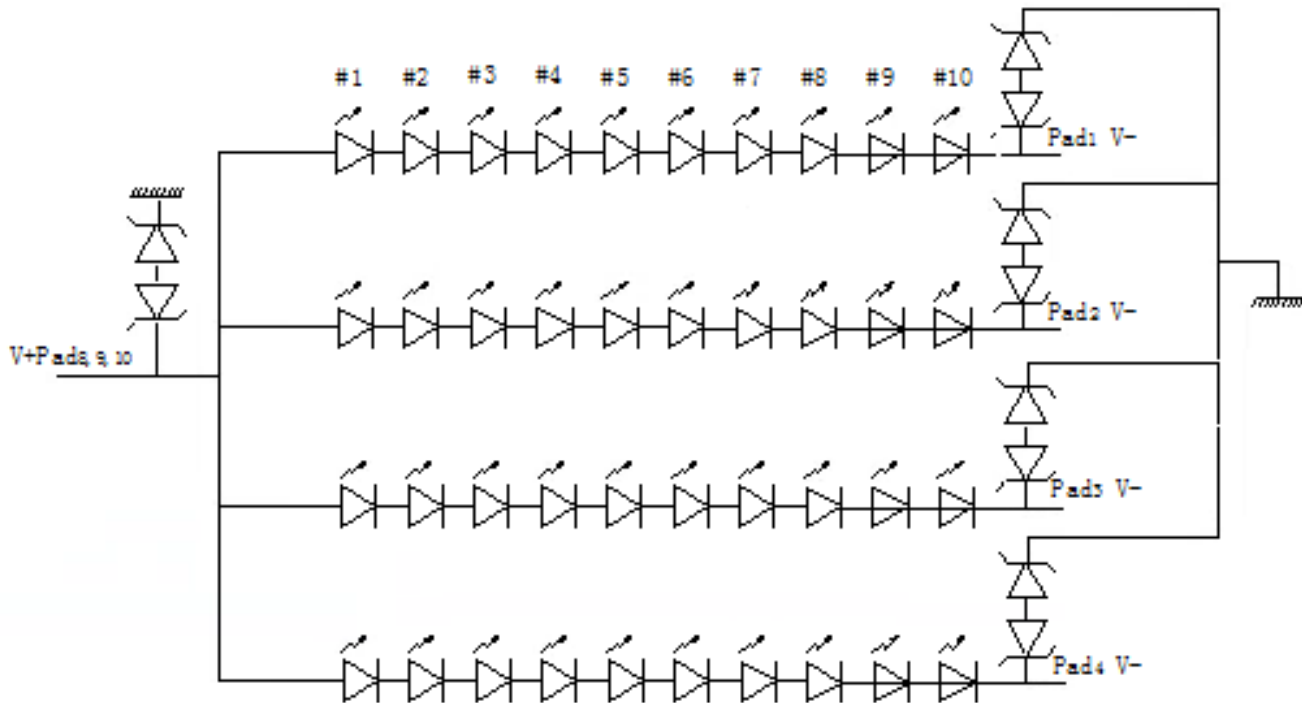

Figure 6. LED Structure

4.0 OPTICAL SPECIFICATION

4.1 Overview

The test of optical specifications shall be measured in a dark room (ambient luminance ≤ 1 lux and temperature = $25 \pm 2^\circ\text{C}$) with the equipment of luminance meter system (PR730&PR810) and test unit shall be located at an approximate distance 50cm from the LCD surface at a viewing angle of θ and Φ equal to 0° . We refer to $\theta=0$ ($=\theta_3$) as the 3 o'clock direction (the "right"), $\theta=90$ ($=\theta_{12}$) as the 12 o'clock direction ("upward"), $\theta=180$ ($=\theta_9$) as the 9 o'clock direction ("left") and $\theta=270$ ($=\theta_6$) as the 6 o'clock direction ("bottom"). While scanning θ and/or Φ , the center of the measuring spot on the display surface shall stay fixed. The backlight should be operating for 30 minutes prior to measurement. VDD shall be $3.3 \pm 0.3\text{V}$ at 25°C . Optimum viewing angle direction is 6 o'clock.

4.2 Optical Specifications

<Table 5. Optical Specifications>

Parameter		Symbol	Condition	Min.	Typ.	Max.	Unit	Remark
Viewing Angle Range	Horizontal	θ_3	CR > 10	-	85	-	Deg.	Note 1
		θ_9		-	85	-	Deg.	
	Vertical	θ_{12}		-	85	-	Deg.	
		θ_6		-	85	-	Deg.	
Luminance Contrast Ratio		CR	$\theta = 0^\circ$	600	800	-		Note 2
Luminance of White	5 Points	Y_w	$\theta = 0^\circ$ ILED = 21mA	255	300	-	cd/m ²	Note 3
White Luminance Uniformity	5 Points	ΔY_5		80	-	-		Note 4
	13 Points	ΔY_{13}		60	-	-		
White Chromaticity		W_x	$\theta = 0^\circ$	0.283	0.313	0.343		Note 5
		W_y		0.299	0.329	0.359		
Reproduction of Color	Red	R_x	$\theta = 0^\circ$	-0.03	0.64	+0.03		
		R_y			0.33			
	Green	G_x			0.30			
		G_y			0.60			
	Blue	B_x			0.15			
		B_y			0.06			
Color Gamut				-	72	-	%	
Response Time (Rising + Falling)		T_{RT}	$T_a = 25^\circ\text{C}$ $\theta = 0^\circ$	-	30	35	ms	Note 6
Cross Talk		CT	$\theta = 0^\circ$	-	-	2.0	%	Note 7

Notes :

1. Viewing angle is the angle at which the contrast ratio is greater than 10. The viewing angles are determined for the horizontal or 3, 9 o'clock direction and the vertical or 6, 12 o'clock direction with respect to the optical axis which is normal to the LCD surface (see Figure 7).
2. Contrast measurements shall be made at viewing angle of $\Theta = 0$ and at the center of the LCD surface. Luminance shall be measured with all pixels in the view field set first to white, then to the dark (black) state . (see Figure 7) Luminance Contrast Ratio (CR) is defined mathematically.

$$CR = \frac{\text{Luminance when displaying a white raster}}{\text{Luminance when displaying a black raster}}$$

3. Center Luminance of white is defined as luminance values of 5 point average across the LCD surface. Luminance shall be measured with all pixels in the view field set first to white. This measurement shall be taken at the locations shown in Figure 8 for a total of the measurements per display.
4. The White luminance uniformity on LCD surface is then expressed as : $\Delta Y = \text{Minimum Luminance of 5(or 13) points} / \text{Maximum Luminance of 5(or 13) points.}$ (see Figure 8 and Figure 9).
5. The color chromaticity coordinates specified in Table 5 shall be calculated from the spectral data measured with all pixels first in red, green, blue and white. Measurements shall be made at the center of the panel.
6. The electro-optical response time measurements shall be made as Figure 10 by switching the “data” input signal ON and OFF. The times needed for the luminance to change from 10% to 90% is T_r , and 90% to 10% is T_r .
7. Cross-Talk of one area of the LCD surface by another shall be measured by comparing the luminance (YA) of a 25mm diameter area, with all display pixels set to a gray level, to the luminance (YB) of that same area when any adjacent area is driven dark. (See Figure 11).

4.3 Optical Measurements

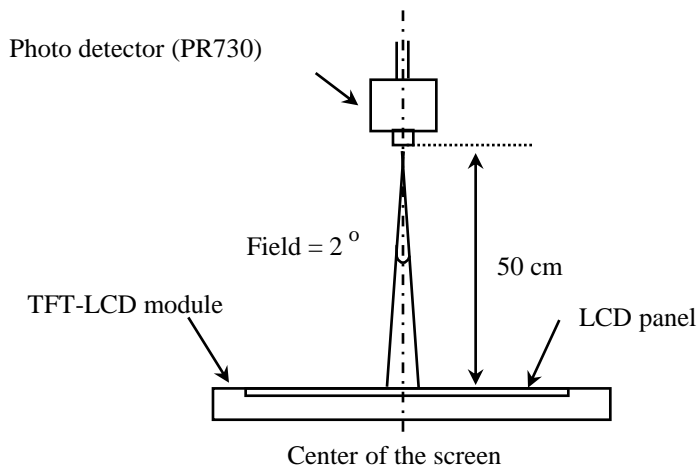

Optical characteristics measurement setup

Figure 7. Measurement Set Up

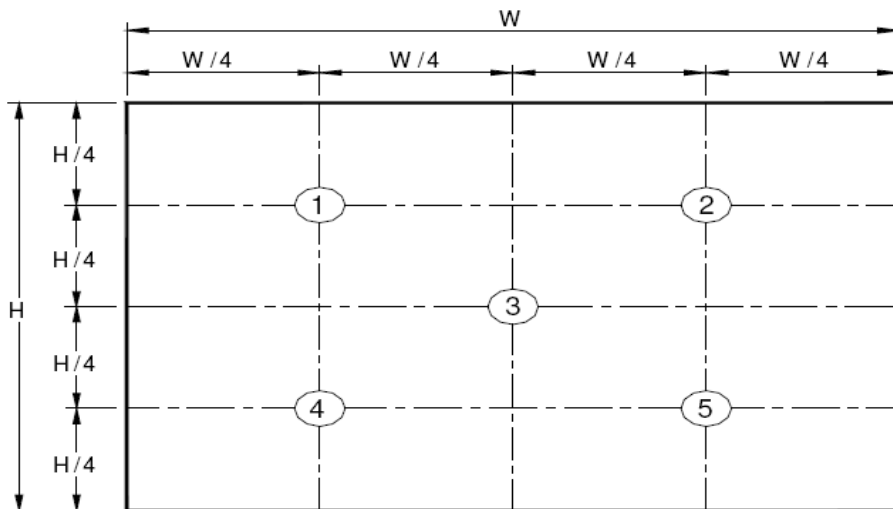

Figure 8. White Luminance and Uniformity Measurement Locations (5 points)

Center Luminance of white is defined as luminance values of center 5 points across the LCD surface. Luminance shall be measured with all pixels in the view field set first to white. This measurement shall be taken at the locations shown in Figure 7 for a total of the measurements per display.

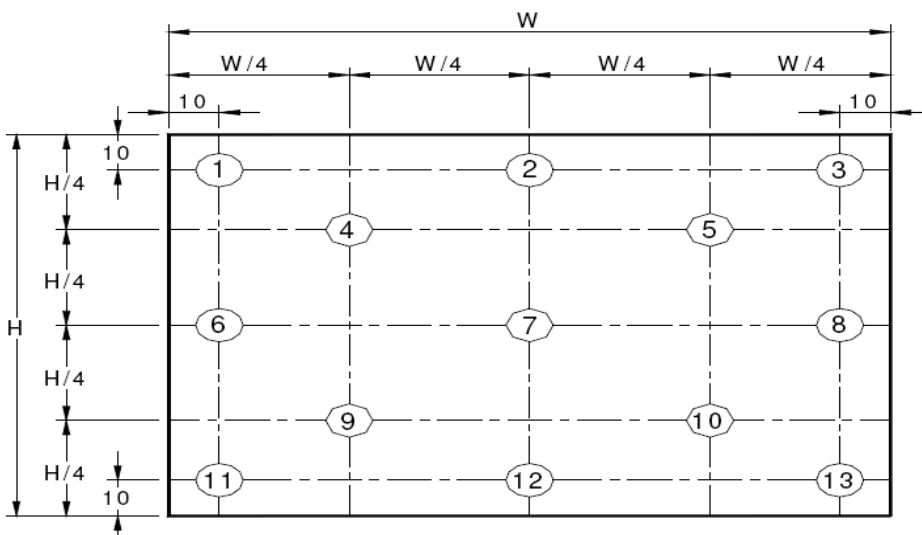

Figure 9. Uniformity Measurement Locations (13 points)

The White luminance uniformity on LCD surface is then expressed as : $\Delta Y5 = \text{Minimum Luminance of five points} / \text{Maximum Luminance of five points}$ (see Figure 8) , $\Delta Y13 = \text{Minimum Luminance of 13 points} / \text{Maximum Luminance of 13 points}$ (see Figure 9).

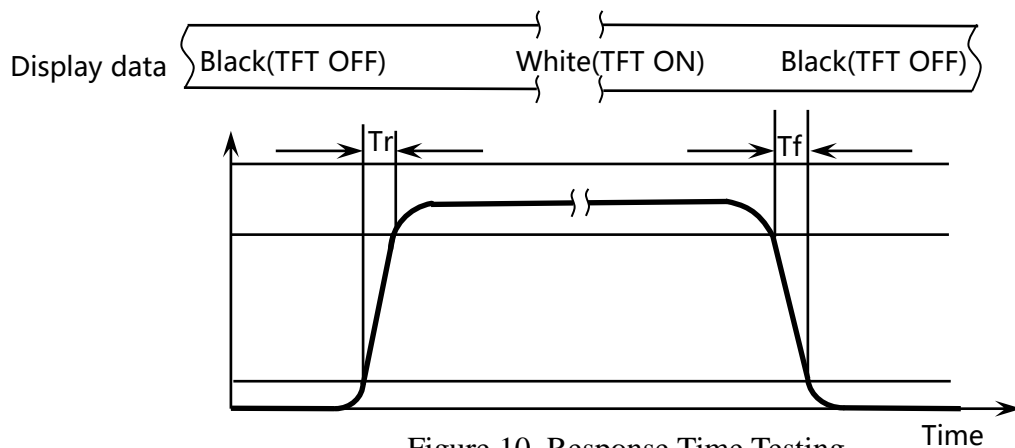
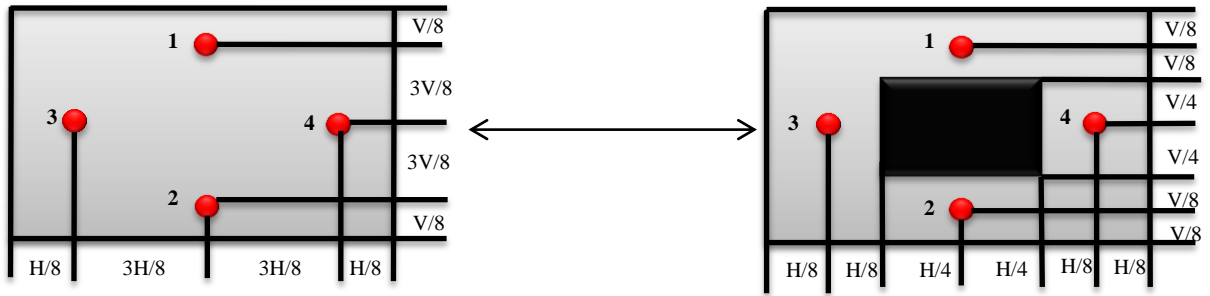

Figure 10. Response Time Testing

The electro-optical response time measurements shall be made as shown in Figure 10 by switching the “data” input signal ON and OFF. Tf: The luminance to change from 90% to 10% ,Tr: The luminance to change from 10% to 90% .

The test system : PR810



$$\text{Cross Talk (\%)} = \left| \frac{Y_B - Y_A}{Y_A} \right| \times 100$$

Figure 11. Cross Talk Modulation Test Description

Where:

Y_A = Initial luminance of measured area (cd/m²)

Y_B = Subsequent luminance of measured area (cd/m²)

The location 1/2/3/4 measured will be exactly the same in both patterns. The test background gray is from L64 to L192. Take the largest data as the result.

Cross Talk of one area of the LCD surface by another shall be measured by comparing the luminance (Y_A) of a 25mm diameter area, with all display pixels set to a gray level, to the luminance (Y_B) of that same area when any adjacent area is driven dark. (Refer to Figure 11)

The test system: PR730

5.0 INTERFACE CONNECTION

5.1 Electrical Interface Connection

The electronics interface connector is UJU IS050-L30B-C10 or Compatible.

The connector interface pin assignments are listed in Table 6.

<Table 6. Pin Assignments for the Interface Connector>

Terminal	Symbol	Functions
Pin No.	Symbol	Description
1	NC	No Connection
2	H_GND	Ground
3	LANE1_N	eDP RX Channel 1 Negative
4	LANE1_P	eDP RX Channel 1 Positive
5	H_GND	Ground
6	LANE0_N	eDP RX Channel 0 Negative
7	LANE0_P	eDP RX Channel 0 Positive
8	H_GND	Ground
9	AUX_CH_P	eDP AUX CH Positive
10	AUX_CH_N	eDP AUX CH Negative
11	H_GND	Ground
12	LCD_VCC	Power Supply, 3.3V (typ.)
13	LCD_VCC	Power Supply, 3.3V (typ.)
14	NC	No Connection
15	H_GND	Ground
16	H_GND	Ground
17	HPD	Hot Plug Detect Output
18	BL_GND	LED Ground
19	BL_GND	LED Ground
20	BL_GND	LED Ground
21	BL_GND	LED Ground
22	BL_ENABLE	LED Enable Pin(+3.3V Input)
23	BL_PWM	System PWM Signal Input
24	NC	No Connection
25	NC	No Connection
26	BL_POWER	LED Power Supply 5V-21V
27	BL_POWER	LED Power Supply 5V-21V
28	BL_POWER	LED Power Supply 5V-21V
29	BL_POWER	LED Power Supply 5V-21V
30	NC	No Connection

5.2 eDP Interface

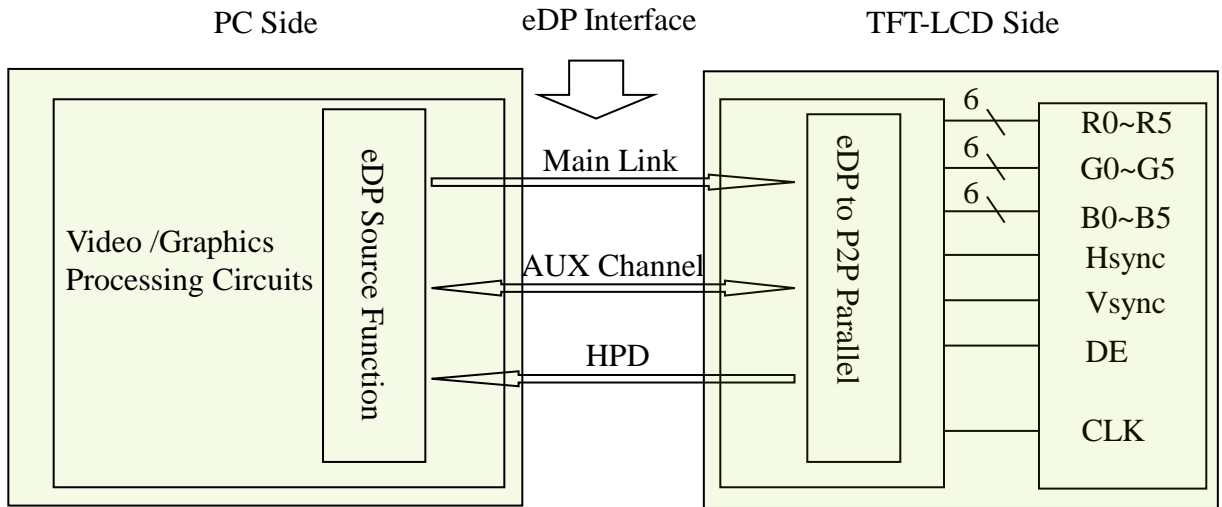

Figure 12. eDP Interface Architecture

Note:

Transmitter : Parade DP501 or equivalent.

Transmitter is not contained in module.

5.3 Data Input Format

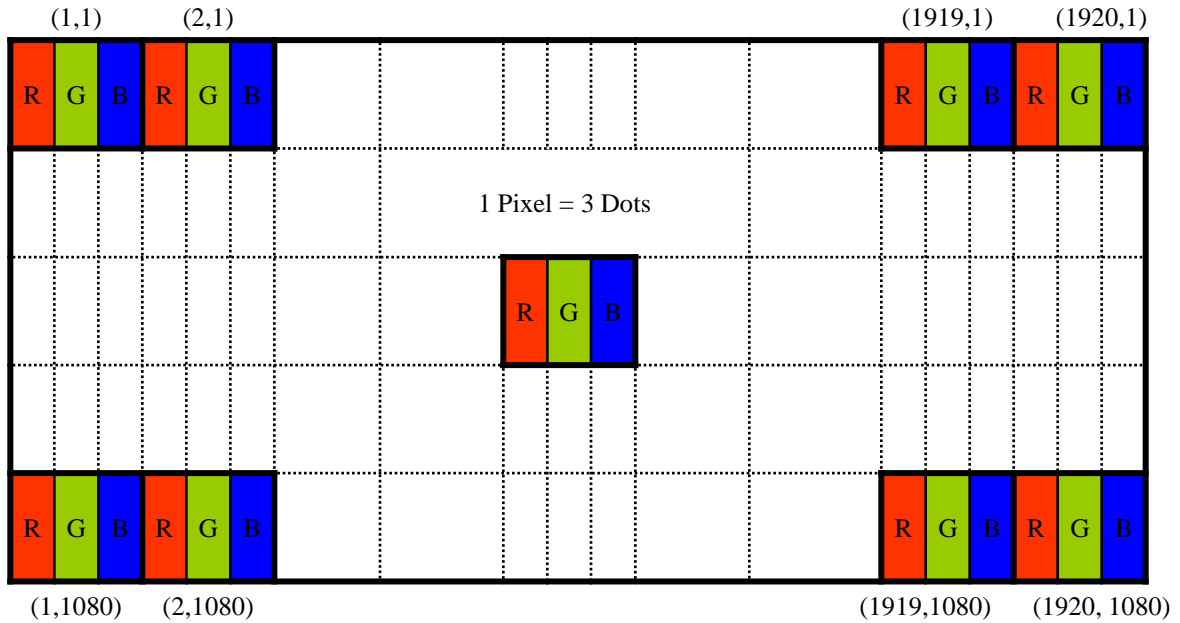

Figure 13. Display Position of Input Data (V-H)

5.4 Back-light & LCM Interface Connection

BLU Interface Connector: UJU PF040-B09B-C09 or Compatible.

<Table 7. Pin Assignments for the BLU Connector>

Pin No.	Symbol	Description	Pin No.	Symbol	Description
1	Vout	LED anode connection	6	LED	LED cathode connection
2	Vout	LED anode connection	7	LED	LED cathode connection
3	NC	No Connection	8	LED	LED cathode connection
4	GND	Ground	9	LED	LED cathode connection
5	NC	No Connection			

6.0 SIGNAL TIMING SPECIFICATION

6.1 The NV133FHM-N56 V8.0 Is Operated By The DE Only

< Table 8. Signal Timing Specification >

Item		Symbols	Min	Typ	Max	Unit
Clock	Frequency	1/Tc	151.6	152.8	154.2	MHz
Frame Period		Tv	1132	1140	1148	lines
			-	60	-	Hz
			-	16.67	-	ms
Vertical Display Period		Tvd	-	1080	-	lines
One line Scanning Period		Th	2230	2235	2238	clocks
Horizontal Display Period		Thd	-	1920	-	clocks

Note : The above is as optimized setting.

6.2 eDP Rx Interface Timing Parameter

The specification of the eDP Rx interface timing parameter is shown in Table 9.

<Table 9. eDP Main-Link RX TP4 Package Pin Parameters>

Item	Symbol	Min	Typ	Max	Unit	Remark
Spread spectrum clock (Link clock down-spreading)	ssc	-	0.5	-	%	
Differential peak-to-peak input voltage at package pins	VRX-DIFFp-p	100	-	1320	mV	
Rx input DC common mode voltage	VRX_DC_CM	-	GND	-	V	
Differential termination resistance	RRX-DIFF	80	100	120	Ω	
Single-ended termination resistance	RRX-SE	40	-	60	Ω	
Rx short circuit current limit	IRX_SHORT	-	-	20	mA	
Intra-pair skew at Rx package pins (HBR) RX intra-pair skew tolerance at HBR	LRX_SKEW_INTRA_PAIR	-	-	150	ps	

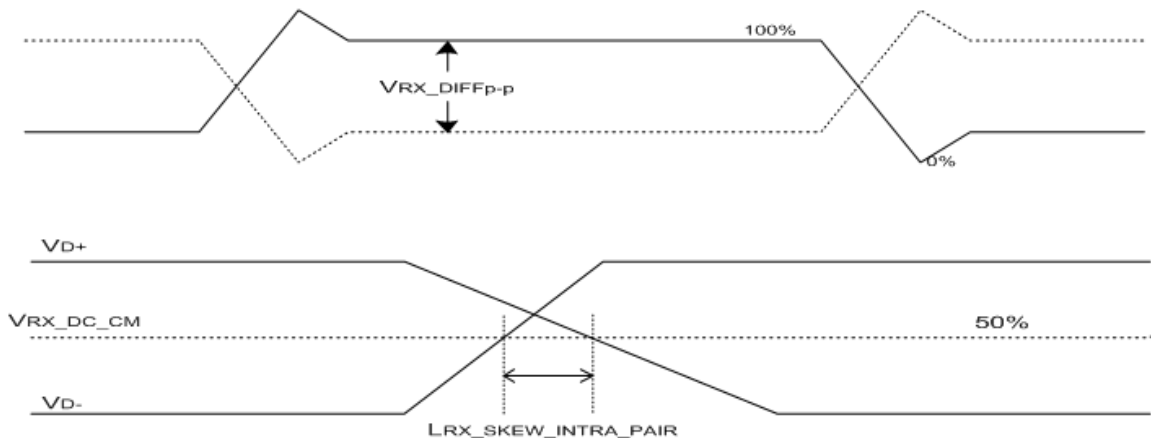

Figure 14. VRX-DIFFp-p & LRX_SKEW_INTRA_PAIR

7.0 INPUT SIGNALS, BASIC DISPLAY COLORS & GRAY SCALE OF COLORS

<Table 10. Input Signal & Basic Display Colors & Gray Scale of Colors >

	Colors & Gray scale	Data signal																	
		R0	R1	R2	R3	R4	R5	G0	G1	G2	G3	G4	G5	B0	B1	B2	B3	B4	B5
Basic colors	Black	0	0	0	0	0	0	0	0	0	0	0	0	0	0	0	0	0	0
	Blue	0	0	0	0	0	0	0	0	0	0	0	0	1	1	1	1	1	1
	Green	0	0	0	0	0	0	1	1	1	1	1	1	0	0	0	0	0	0
	Light Blue	0	0	0	0	0	0	1	1	1	1	1	1	1	1	1	1	1	1
	Red	1	1	1	1	1	1	0	0	0	0	0	0	0	0	0	0	0	0
	Purple	1	1	1	1	1	1	0	0	0	0	0	0	1	1	1	1	1	1
	Yellow	1	1	1	1	1	1	1	1	1	1	1	1	0	0	0	0	0	0
	White	1	1	1	1	1	1	1	1	1	1	1	1	1	1	1	1	1	1
Gray scale of Red	Black	0	0	0	0	0	0	0	0	0	0	0	0	0	0	0	0	0	0
	△	1	0	0	0	0	0	0	0	0	0	0	0	0	0	0	0	0	0
	Darker	0	1	0	0	0	0	0	0	0	0	0	0	0	0	0	0	0	0
	△				↑						↑						↑		
	▽				↓						↓						↓		
	Brighter	1	0	1	1	1	1	0	0	0	0	0	0	0	0	0	0	0	0
Gray scale of Green	Black	0	0	0	0	0	0	0	0	0	0	0	0	0	0	0	0	0	0
	△	0	0	0	0	0	0	1	0	0	0	0	0	0	0	0	0	0	0
	Darker	0	0	0	0	0	0	0	1	0	0	0	0	0	0	0	0	0	0
	△				↑						↑						↑		
	▽				↓						↓						↓		
	Brighter	0	0	0	0	0	0	1	0	1	1	1	1	0	0	0	0	0	0
Gray scale of Blue	Black	0	0	0	0	0	0	0	0	0	0	0	0	0	0	0	0	0	0
	△	0	0	0	0	0	0	0	0	0	0	0	0	1	0	0	0	0	0
	Darker	0	0	0	0	0	0	0	0	0	0	0	0	0	1	0	0	0	0
	△				↑						↓						↑		
	▽				↓						↓						↓		
	Brighter	0	0	0	0	0	0	0	0	0	0	0	0	1	0	1	1	1	1
Gray scale of White & Black	Black	0	0	0	0	0	0	0	0	0	0	0	0	0	0	0	0	0	0
	△	1	0	0	0	0	0	1	0	0	0	0	0	1	0	0	0	0	0
	Darker	0	1	0	0	0	0	0	1	0	0	0	0	0	1	0	0	0	0
	△				↑						↑						↑		
	▽				↓						↓						↓		
	Brighter	1	0	1	1	1	1	1	0	1	1	1	1	1	0	1	1	1	1
White	1	1	1	1	1	1	1	1	1	1	1	1	1	1	1	1	1	1	

8.0 POWER SEQUENCE

To prevent a latch-up or DC operation of the LCD module, the power on/off sequence shall be as shown in below.

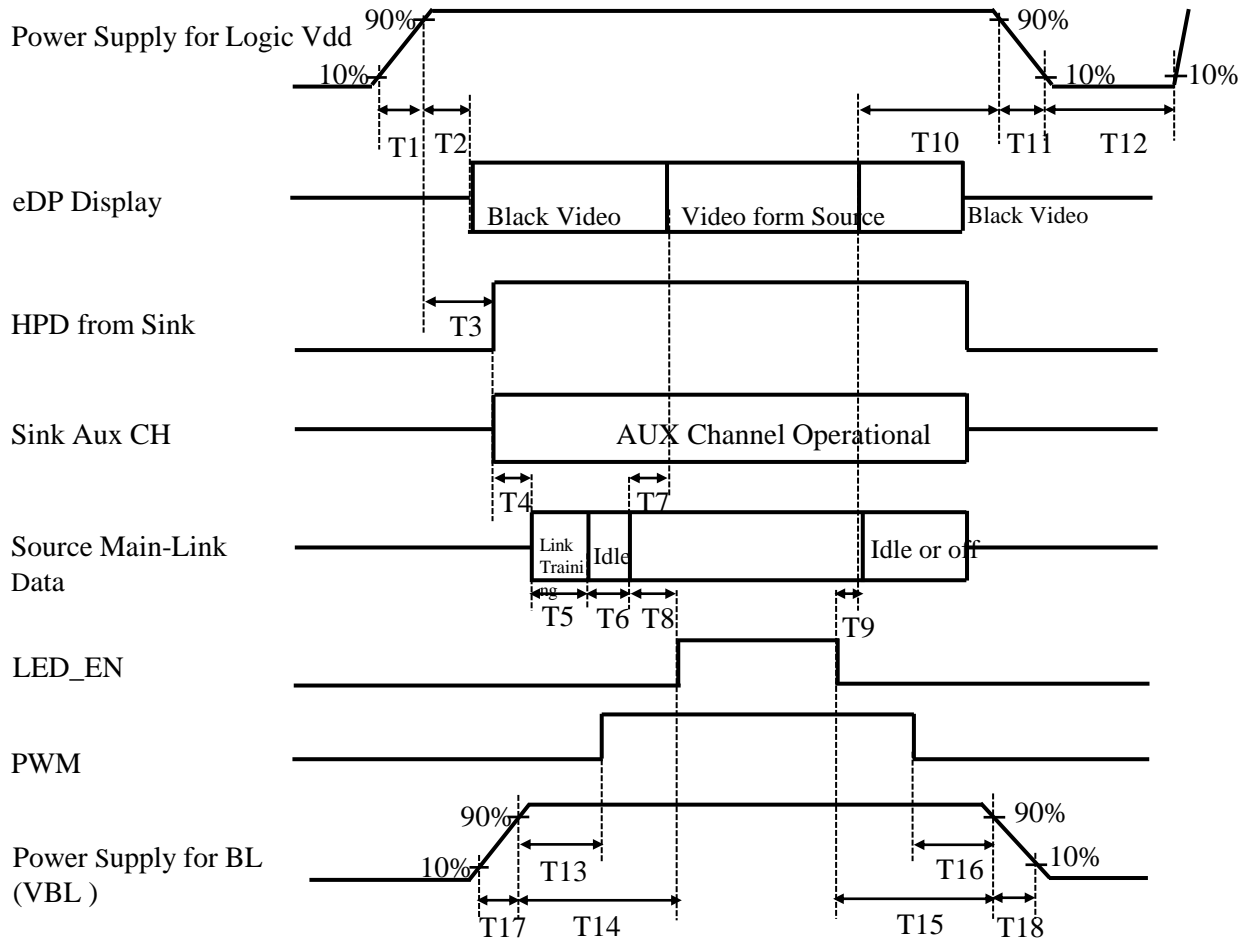

Figure 15. Power Sequence

- $0.5\text{ms} \leq T1 \leq 10\text{ms}$
- $0\text{ms} < T2 \leq 200\text{ms}$
- $0\text{ms} < T3 \leq 200\text{ms}$
- $T3+T4+T5+T6+T8 > 200\text{ms}$
- $0\text{ms} < T7 \leq 50\text{ms}$
- $T7 < T8$
- $0\text{ms} < T9$
- $0\text{ms} < T10 < 500\text{ms}$
- $0.5\text{ms} \leq T11 \leq 10\text{ms}$
- $500\text{ms} \leq T12$
- $0\text{ms} < T13$
- $0\text{ms} < T14$
- $0\text{ms} < T15$
- $0\text{ms} < T16$
- $0.5\text{ms} \leq T17$
- $0.5\text{ms} \leq T18$

Notes:

- When the power supply VDD is 0V, keep the level of input signals on the low or keep high impedance.
- Do not keep the interface signal high impedance when power is on. Back Light must be turn on after power for logic and interface signal are valid.

9.0 Connector Description

Physical interface is described as for the connector on LCM.

These connectors are capable of accommodating the following signals and will be following components.

9.1 TFT LCD Module

< Table 11. Signal Connector >

Connector Name /Description	For Signal Connector
Manufacturer	UJU or Compatible
Type/ Part Number	IS050-L30B-C10 or Compatible
Mating Housing/ Part Number	I-PEX 20454-030T or Compatible

10.0 MECHANICAL CHARACTERISTICS

10.1 Dimensional Requirements

Figure 20 shows mechanical outlines for the model NV133FHM-N56 V8.0. Other parameters are shown in Table 12.

<Table 12. Dimensional Parameters>

Parameter	Specification	Unit
Active Area	293.76 (H) × 165.24 (V)	mm
Number of pixels	1920 (H) X 1080 (V) (1 pixel = R + G + B dots)	pixels
Pixel pitch	153 (H) × 153 (V)	um
Pixel arrangement	RGB Vertical stripe	
Display colors	262K(6bit)	
Display mode	Normally Black	
Dimensional outline	299.96 +/-0.3(H)*186.92 +/-0.5(V) (W/PCB)*2.0Max	mm
Weight	170 (max)	g

10.2 Mounting

See Figure 20.

10.3 Glare and Polarizer Hardness.

The surface of the LCD has an glare coating to maximize readability and hard coating to reduce scratching.

10.4 Light Leakage

There shall not be visible light from the back-lighting system around the edges of the screen as seen from a distance 50cm from the screen with an overhead light level of 350lux.

11.0 RELIABILITY TEST

The reliability test items and its conditions are shown in below.

<Table 13. Reliability Test>

No	Test Items	Conditions
1	High temperature storage test	Ta = 60°C , 60%RH, 240 hrs
2	Low temperature storage test	Ta = -20°C , 240 hrs
3	High temperature & high humidity operation test	Ta = 50°C , 80%RH, 240 hrs
4	High temperature operation test	Ta = 50°C , 60%RH, 240 hrs
5	Low temperature operation test	Ta = 0°C , 240 hrs
6	Thermal shock	Ta = -20 °C ↔ 60 °C (0.5 hr), 60% ±3%RH, 100 cycle
7	Vibration test (non-operating)	Ta = 25°C , 60%RH, 1.5G, 10~500Hz, Half Sine X,Y,Z / Sweep rate : 1 hour
8	Shock test (non-operating)	Ta = 25°C , 60%RH, 220G, Half Sine Wave 2msec±X,±Y,±Z Once for each direction
9	Electro-static discharge test (non-operating)	Air : 150 pF, 330Ω, 15 KV Contact : 150 pF, 330Ω, 8 KV Ta = 25°C , 60%RH,

12.0 HANDLING & CAUTIONS

(1) Cautions when taking out the module

- Pick the pouch only, when taking out module from a shipping package.

(2) Cautions for handling the module

- As the electrostatic discharges may break the LCD module, handle the LCD module with care. Peel a protection sheet off from the LCD panel surface as slowly as possible.
- As the LCD panel and back - light element are made from fragile glass material, impulse and pressure to the LCD module should be avoided.
- As the surface of the polarizer is very soft and easily scratched, use a soft dry cloth without chemicals for cleaning.
- Do not pull the interface connector in or out while the LCD module is operating.
- Put the module display side down on a flat horizontal plane.
- Handle connectors and cables with care.

(3) Cautions for the operation

- When the module is operating, do not lose CLK, ENAB signals. If any one of these signals is lost, the LCD panel would be damaged.
- Obey the supply voltage sequence. If wrong sequence is applied, the module would be damaged.

(4) Cautions for the atmosphere

- Dew drop atmosphere should be avoided.
- Do not store and/or operate the LCD module in a high temperature and/or humidity atmosphere. Storage in an electro-conductive polymer packing pouch and under relatively low temperature atmosphere is recommended.

(5) Cautions for the module characteristics

- Do not apply fixed pattern data signal to the LCD module at product aging.
- Applying fixed pattern for a long time may cause image sticking.

(6) Other cautions

- Do not disassemble and/or re-assemble LCD module.
- Do not re-adjust variable resistor or switch etc.
- When returning the module for repair or etc. Please pack the module not to be broken. We recommend to use the original shipping packages.

13.0 LABEL

(1) Product Label

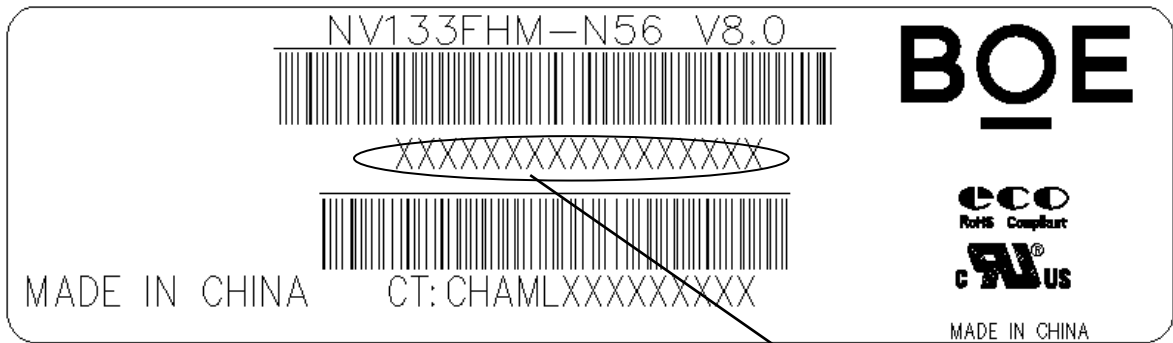

Figure 16. Product Label

Module ID Naming Rule:

<Table 14. Module ID Naming Rule>

Digit	1	2	3	4	5	6	7	8	9	10	11	12	13	14	15	16	17
Code	S	L	S	5	1	2	3	5	9	4	2	0	0	0	1	D	B
Description	Model Code /GBN		Grade	Line	Year		Month	Model Extension Code (Last 4 Digits Of FGCOD)				Serial No 00001-ZZZZZZ					

(2) High voltage caution label

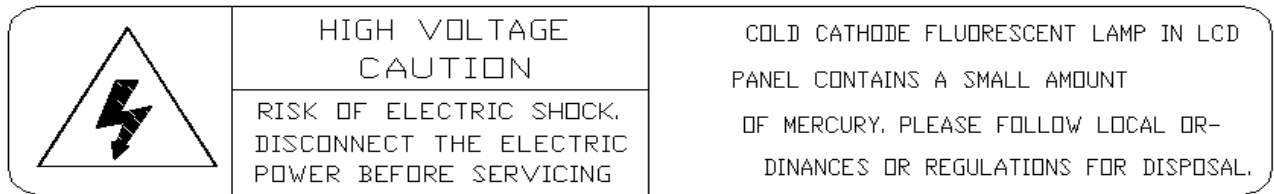

Figure 17. High Voltage Caution Label

(3) Box Label

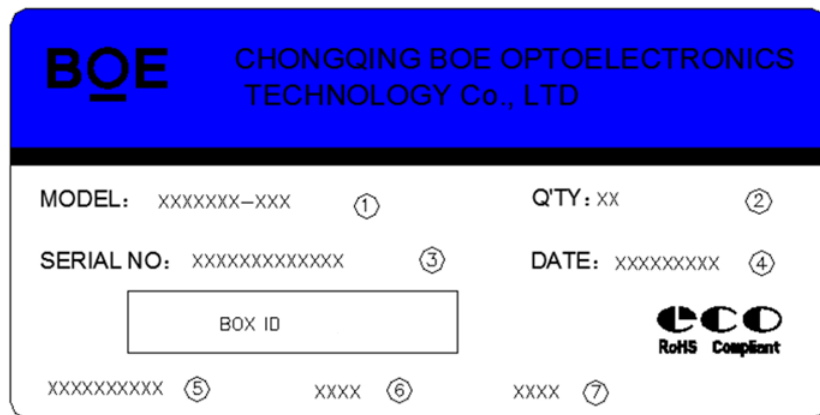

Figure 18. Box Label

Serial number marked part needs to print, show as follows:

1. FG-CODE(First 12 bit)
2. Product quantity
3. Box ID
4. Date
5. The client section material number(The client)
6. FG-Code Last four bit ---DRA2
7. The supplier code

Total Size:100×50mm

<Table 15. Box Label Naming Rule >

Digit Code	1	2	3	4	5	6	7	8	9	10	11	12	13
Code	B	9	A	F	1	7	8	N	0	0	3	2	7
Description	Product Name		Product Grade	B8	Year		Month	Revision	BOX Serial Number				

14.0 PACKING INFORMATION

14.1 Packing Order

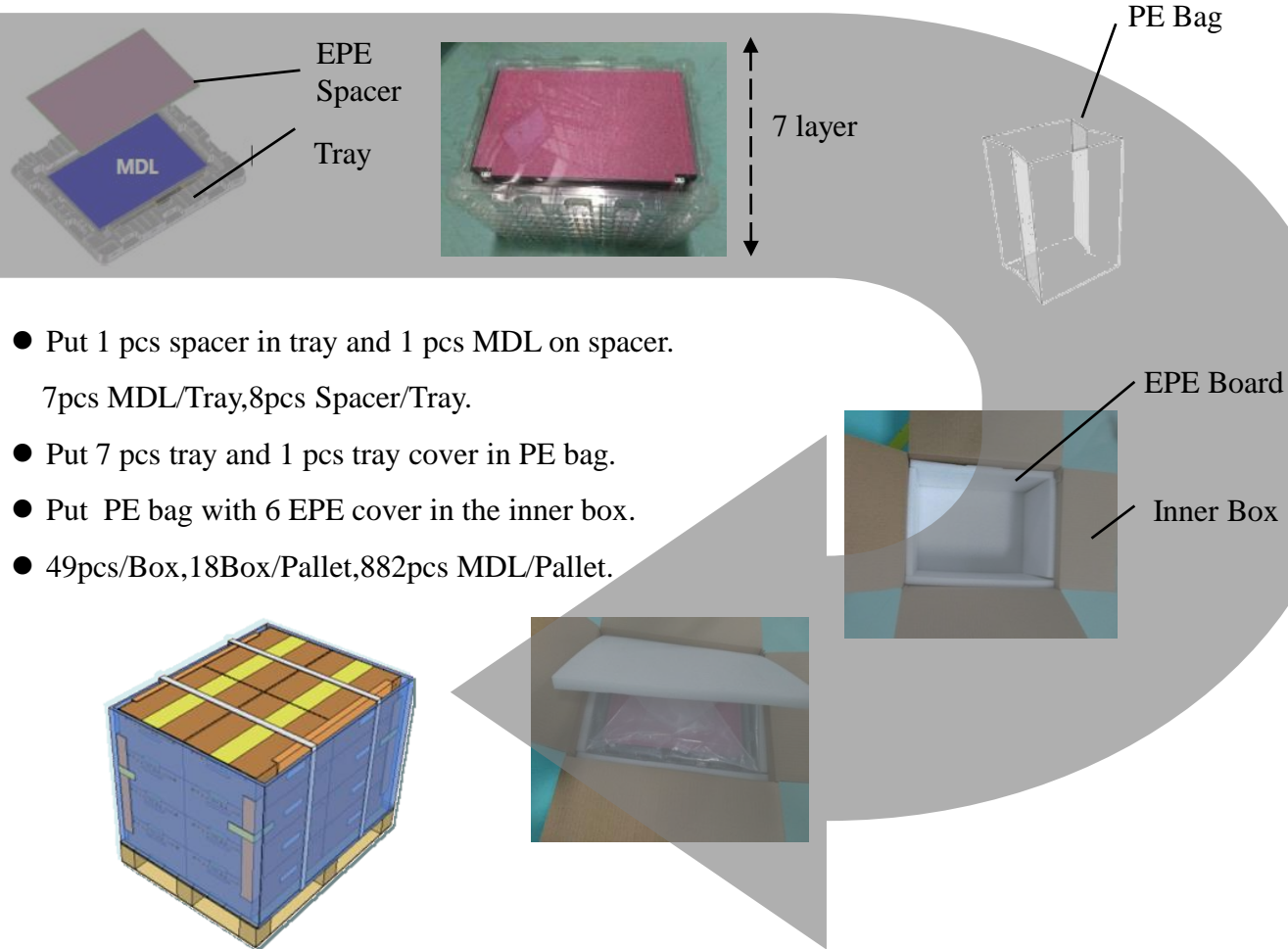

Figure 19. Packing Order

14.2 Note

- Box dimension: 480mm*350mm*285mm
- Package quantity in one box: 49pcs
- Total weight: 8.62kg/Box

15.0 MECHANICAL OUTLINE DIMENSION

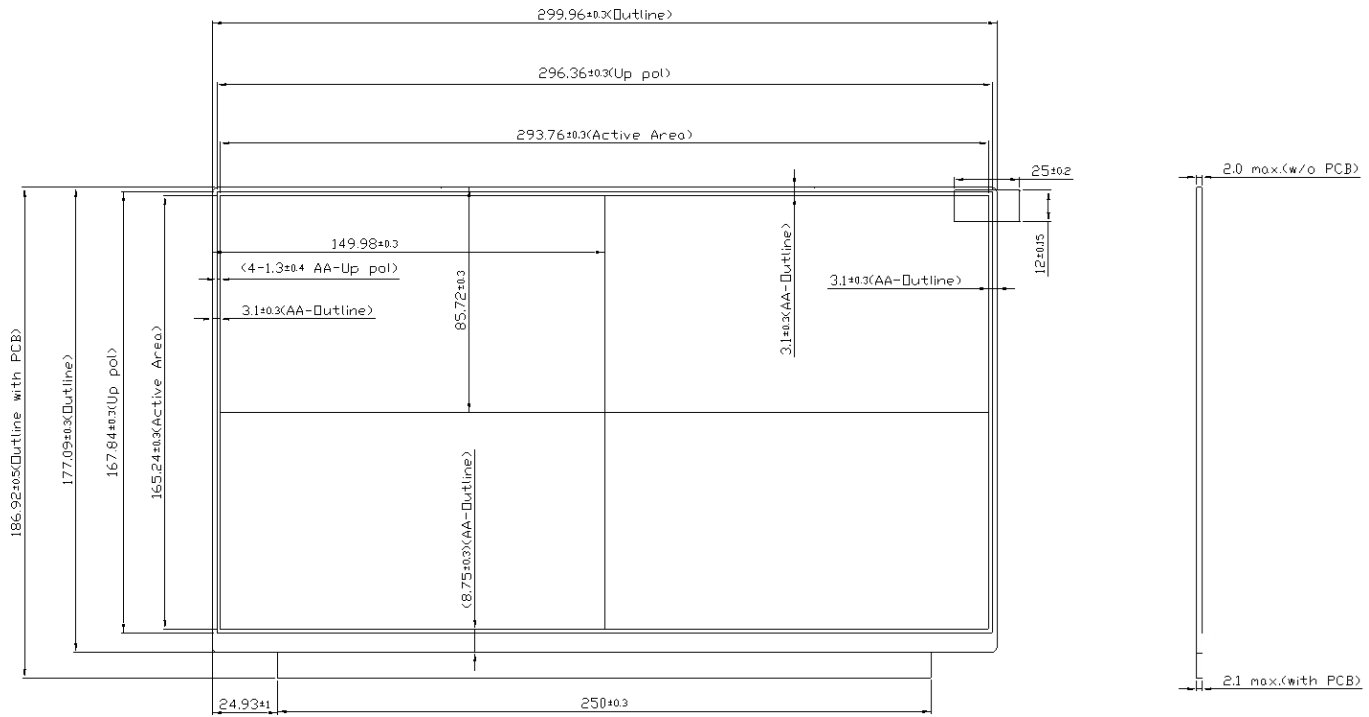

Figure 20. TFT-LCD Module Outline Dimension (Front View)

Note:

1. Top Polarizer is the highest part.
2. Curve Spec: $0 < d \leq 0.5$ mm.
3. No light leakage from all 4 corners of LCM.
4. Size Unit: mm.
5. General Tolerance: ± 0.3 mm.

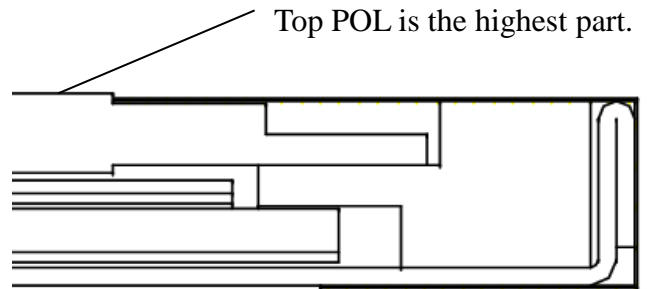

Figure 21. Highest Point Position

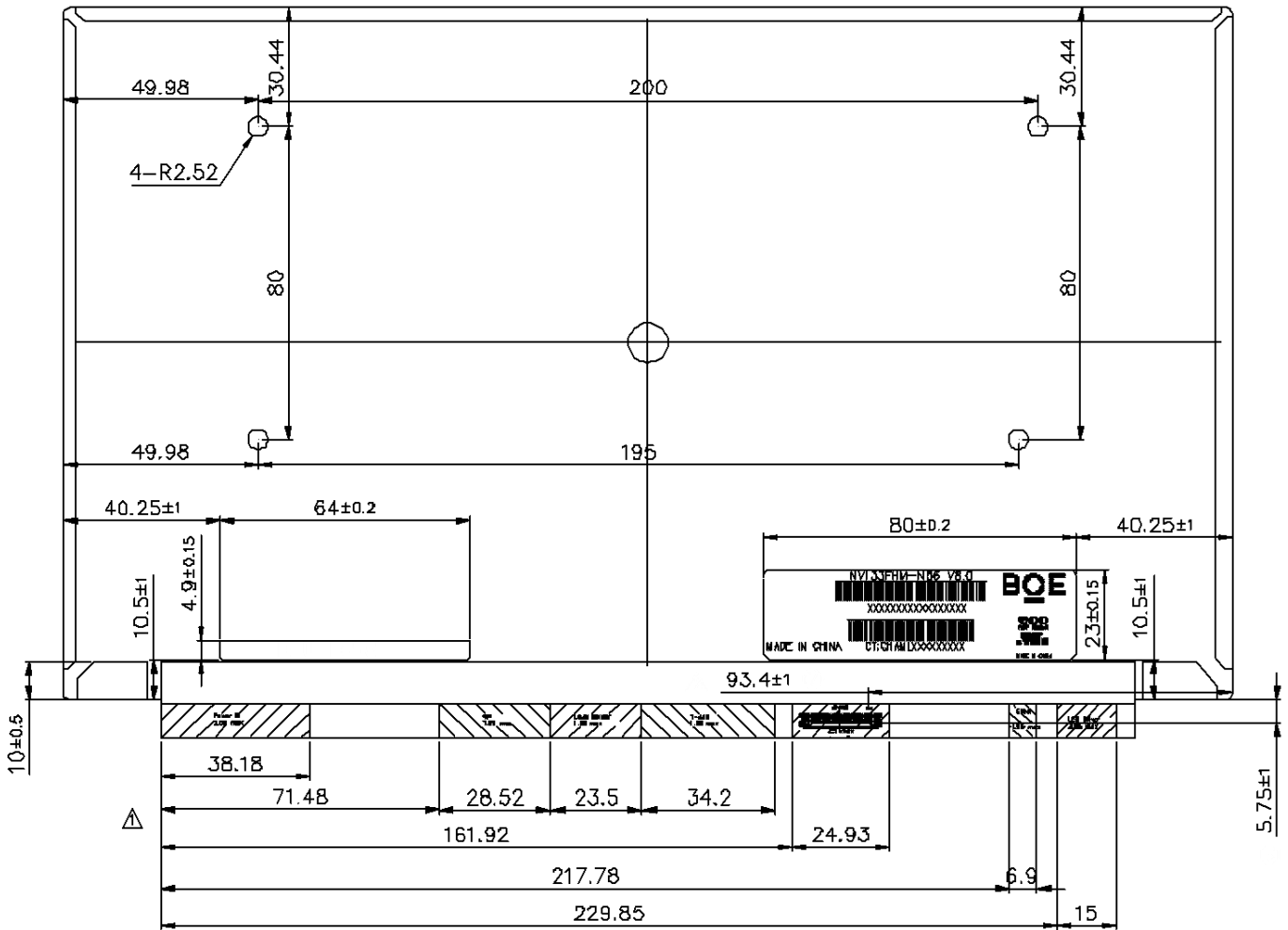

Figure 22. TFT-LCD Module Outline Dimensions (Rear view)

Note:

1. Top Polarizer is the highest part.
2. Curve Spec: $0 \leq d \leq 0.5$ mm.
3. No light leakage from all 4 corners of LCM.
4. Size Unit: mm.
5. General Tolerance: ± 0.3 mm.

16.0 EDID Table

Address (HEX)	Function	Hex	Dec	Input values.	Notes
00	Header	00	0	0	EDID Header
01		FF	255	255	
02		FF	255	255	
03		FF	255	255	
04		FF	255	255	
05		FF	255	255	
06		FF	255	255	
07		00	0	0	
08	ID Manufacturer Name	09	9	BOE	ID = BOE
09		E5	229		
0A	ID Product Code	84	132	1924	ID = 1924
0B		07	7		
0C	32-bit serial No.	00	0		
0D		00	0		
0E		00	0		
0F		00	0		
10	Week of manufacture	01	1	1	
11	Year of Manufacture	1B	27	2017	Manufactured in 2017
12	EDID Structure Ver.	01	1	1	EDID Ver 1.0
13	EDID revision #	04	4	4	EDID Rev. 0.4
14	Video input definition	95	149	-	
15	Max H image size	1D	29	29	29 cm (Approx)
16	Max V image size	11	17	17	17 cm (Approx)
17	Display Gamma	78	120	2.2	Gamma curve = 2.2
18	Feature support	02	2		RGB display, Preferred Timming mode
19	Red/Green low bits	DE	222	-	Red / Green Low Bits
1A	Blue/White low bits	50	80	-	Blue / White Low Bits
1B	Red x high bits	A3	163	0.640	Red (x) = 10100011 (0.64)
1C	Red y high bits	54	84	0.330	Red (y) = 01010100 (0.33)
1D	Green x high bits	4C	76	0.300	Green (x) = 01001100 (0.3)
1E	Green y high bits	99	153	0.600	Green (y) = 10011001 (0.6)
1F	Blue x high bits	26	38	0.150	Blue (x) = 00100110 (0.15)
20	Blue y high bits	0F	15	0.060	Blue (y) = 00001111 (0.06)
21	White x high bits	50	80	0.313	White (x) = 01010000 (0.313)
22	White y high bits	54	84	0.329	White (y) = 01010100 (0.329)
23	Established timing 1	00	0	-	
24	Established timing 2	00	0	-	

25	Established timing 3	00	0	-	
26	Standard timing #1	01	1		Not Used
27		01	1		
28	Standard timing #2	01	1		Not Used
29		01	1		
2A	Standard timing #3	01	1		Not Used
2B		01	1		
2C	Standard timing #4	01	1		Not Used
2D		01	1		
2E	Standard timing #5	01	1		Not Used
2F		01	1		
30	Standard timing #6	01	1		Not Used
31		01	1		
32	Standard timing #7	01	1		Not Used
33		01	1		
34	Standard timing #8	01	1		Not Used
35		01	1		
36	Detailed timing/monitor descriptor #1	B4	180	152.8	152.84MHz Main clock
37		3B	59		
38		80	128	1920	Hor Active = 1920
39		3B	59	315	Hor Blanking = 315
3A		71	113	-	4 bits of Hor. Active + 4 bits of Hor. Blanking
3B		38	56	1080	Ver Active = 1080
3C		3C	60	60	Ver Blanking = 60
3D		40	64	-	4 bits of Ver. Active + 4 bits of Ver. Blanking
3E		30	48	48	Hor Sync Offset = 48
3F		20	32	32	H Sync Pulse Width = 32
40		36	54	3	V sync Offset = 3 line
41		00	0	6	V Sync Pulse width : 6 line
42		26	38	294	Horizontal Image Size = 294 mm (Low 8 bits)
43		A5	165	165	Vertical Image Size = 165 mm (Low 8 bits)
44		10	16	-	4 bits of Hor Image Size + 4 bits of Ver Image Size
45		00	0	0	Hor Border (pixels)
46		00	0	0	Vertical Border (Lines)
47	1A	26		Refer to right table	

48	Detailed timing/monitor descriptor #2	B4	180	152.8	152.84MHz Main clock
49		3B	59		
4A		80	128	1920	Hor Active = 1920
4B		3B	59	315	Hor Blanking = 315
4C		71	113	-	4 bits of Hor. Active + 4 bits of Hor. Blanking
4D		38	56	1080	Ver Active = 1080
4E		76	118	630	Ver Blanking = 630
4F		42	66	-	4 bits of Ver. Active + 4 bits of Ver. Blanking
50		30	48	48	Hor Sync Offset = 48
51		20	32	32	H Sync Pulse Width = 32
52		36	54	3	V sync Offset = 3 line
53		00	0	6	V Sync Pulse width : 6 line
54		26	38	294	Horizontal Image Size = 294 mm (Low 8 bits)
55		A5	165	165	Vertical Image Size = 165 mm (Low 8 bits)
56		10	16	-	4 bits of Hor Image Size + 4 bits of Ver Image Size
57		00	0	0	Hor Border (pixels)
58		00	0	0	Vertical Border (Lines)
59		1A	26		
5A		Detailed timing/monitor descriptor #3	00	0	
5B	00		0		
5C	00		0		
5D	00		0		
5E	00		0		
5F	00		0		
60	00		0		
61	00		0		
62	00		0		
63	00		0		
64	00		0		
65	00	0			
66	00	0			
67	00	0			
68	00	0			
69	00	0			
6A	00	0			
6B	00	0			

6C	Detailed timing/monitor descriptor #4	00	0	0	Detailed Timing Description #4
6D		00	0	0	Flag
6E		00	0	0	Reserved
6F		02	2		For Brightness Table and Power consumption
70		00	0	0	Flag
71		08	8		PWM % [7:0] @ Step 0
72		38	56		PWM % [7:0] @ Step 5
73		FF	255		PWM % [7:0] @ Step 10
74		0A	10		Nits [7:0] @ Step 0
75		3C	60		Nits [7:0] @ Step 5
76		96	150		Nits [7:0] @ Step 10
77		14	20		Panel Electronics Power @32x32 Chess Pattern=
78		0E	14		Backlight Power @60 nits=
79		23	35		Backlight Power @Step 10=
7A		96	150		Nits @ 100% PWM Duty =
7B		00	0	0	Flags
7C		00	0	0	Flags
7D		00	0	0	Flags
7E		Extension flag	00	0	
7F		Checksum	74	116	-